

## DC/DC regulators

Input 3.0 - 5.5 V  
Output Current up to 10 A

### Key Features

- Wide input, 3.0-5.5 Vdc
- Programmable output, 0.75 - 3.6 Vdc
- Under voltage protection
- Over-temperature protection
- Short circuit protection
- Remote sense
- Remote On/Off
- Design for Environment (DfE)



The PMC series of surface mount DC/DC regulators (POL) are intended to be used as local distributed power sources in distributed power architecture level 4. The surface mount design makes the PMC series suitable for applications where board space is limited. The high efficiency and high reliability of the PMC series makes them particularly suited for the communications equipment of today and tomorrow.

These products are manufactured using the most advanced technologies and materials to comply with environmental requirements. Designed to meet high reliability requirements of systems manufacturers, the PMC responds to world-class specifications.

Ericsson Power Modules is an ISO 9001/14001 certified supplier.

## Absolute Maximum Ratings

Characteristics		min	max	Unit
T <sub>ref</sub>	Operating Reference Temperature, see pg. 20	-45	+115	°C
T <sub>S</sub>	Storage temperature	-55	+125	°C
V <sub>I</sub>	Input voltage	-0.3	+5.5	Vdc

### Note:

Stress in excess of Absolute Maximum Ratings may cause permanent damage. Absolute Maximum Ratings, sometimes referred to as no destruction limits, are normally tested with one parameter at a time exceeding the limits of Output data or Electrical Characteristics. If exposed to stress above these limits, function and performance may degrade in an unspecified manner.

## Input

T<sub>ref</sub> = -30 ... +90 °C, V<sub>I</sub> = 3.0...5.5 V unless otherwise specified  
Typ values specified at: T<sub>ref</sub> = +25 °C, V<sub>I</sub>nom, I<sub>O</sub>max = 10A

Characteristics		Conditions	min	typ	max	Unit
V <sub>I</sub>	Input voltage range		3.0		5.5	Vdc
V <sub>Ioff</sub>	Turn-off input voltage	Ramping from higher voltage		2.64		Vdc
V <sub>Ion</sub>	Turn-on input voltage	Ramping from lower voltage		2.9		Vdc
C <sub>I</sub>	Input capacitance			20		µF
P <sub>li</sub>	Input idling power	I <sub>O</sub> = 0 A, V <sub>I</sub> = 5 V			430	mW
P <sub>RC</sub>	Input stand-by power (RC active)	Non operation, V <sub>I</sub> = 5 V			7.5	mW
V <sub>Iac</sub>	Input ripple	20 Hz ... 5 MHz, I <sub>O</sub> max, V <sub>I</sub> = 5 V		300		mV

1) Measured with 2 x 22 µF ceramic capacitors

## Environmental Characteristics

Characteristics			
Random Vibration	JESD 22-B103-B	Frequency Acceleration density	3 ... 500 Hz 0.008 ... 0.2 g <sup>2</sup> /Hz
Sinusoidal vibration	JESD 22-B103-B	Frequency Acceleration amplitude	10 ... 1000 Hz 10 g
Mechanical shock (half sinus)	JESD 22-B104-B	Peak acceleration Duration	50 g 11 ms
Lead integrity	JESD 22-B105-C	weight of 1000g	All terminals
Temperature cycling	JESD22-A104-B <sub>G</sub>	Temperature Number of cycles	-40 ... +125 °C 300
Accelerated damp heat	JESD22-A101-B	Temperature Humidity Duration Bias	+85 °C 85 % RH 1000 hours max input voltage
Solderability	IEC 60068-2-54 (Aged according to JESD22-A101-B, 240h no bias)	Solder immersion depth Time for onset of wetting Wetting force	1 mm < 2.5 s > 200 mN/m
Cold (in operation)	IEC 60068-2-1A, test A <sub>d</sub>	Temperature Duration	-45 °C 72 h
High temperature storage	JESD22-A103-B <sub>A</sub>	Temperature Duration	+125 °C 1000 h

### Note:

Tests pending

## Safety

The PMC 4000 series DC/DC regulators are designed in accordance with safety standards IEC/EN/UL 60 950, *Safety of Information Technology Equipment*.

The DC/DC regulator should be installed in the end-use equipment, in accordance with the requirements of the ultimate application. The input source must be isolated by minimum Reinforced or Double insulation from the primary circuit in accordance with IEC/EN/UL 60 950. If the input voltage to the DC/DC regulator is SELV (Safety Extra Low Voltage) then the output remains SELV under normal and abnormal operating conditions.

It is recommended that a slow blow fuse with a rating of 25A be used at the input of each DC/DC regulator. If a fault occurs in the regulator that imposes a short circuit on the input source, this fuse will provide the following functions:

- Isolate the faulty DC/DC regulator from the input power source not to affect the operation of other parts of the system.
- Protect the distribution wiring from excessive current and power loss thus preventing hazardous overheating.

The flammability rating for all construction parts of the DC/DC regulator meets UL 94V-0.

## Mechanical Data

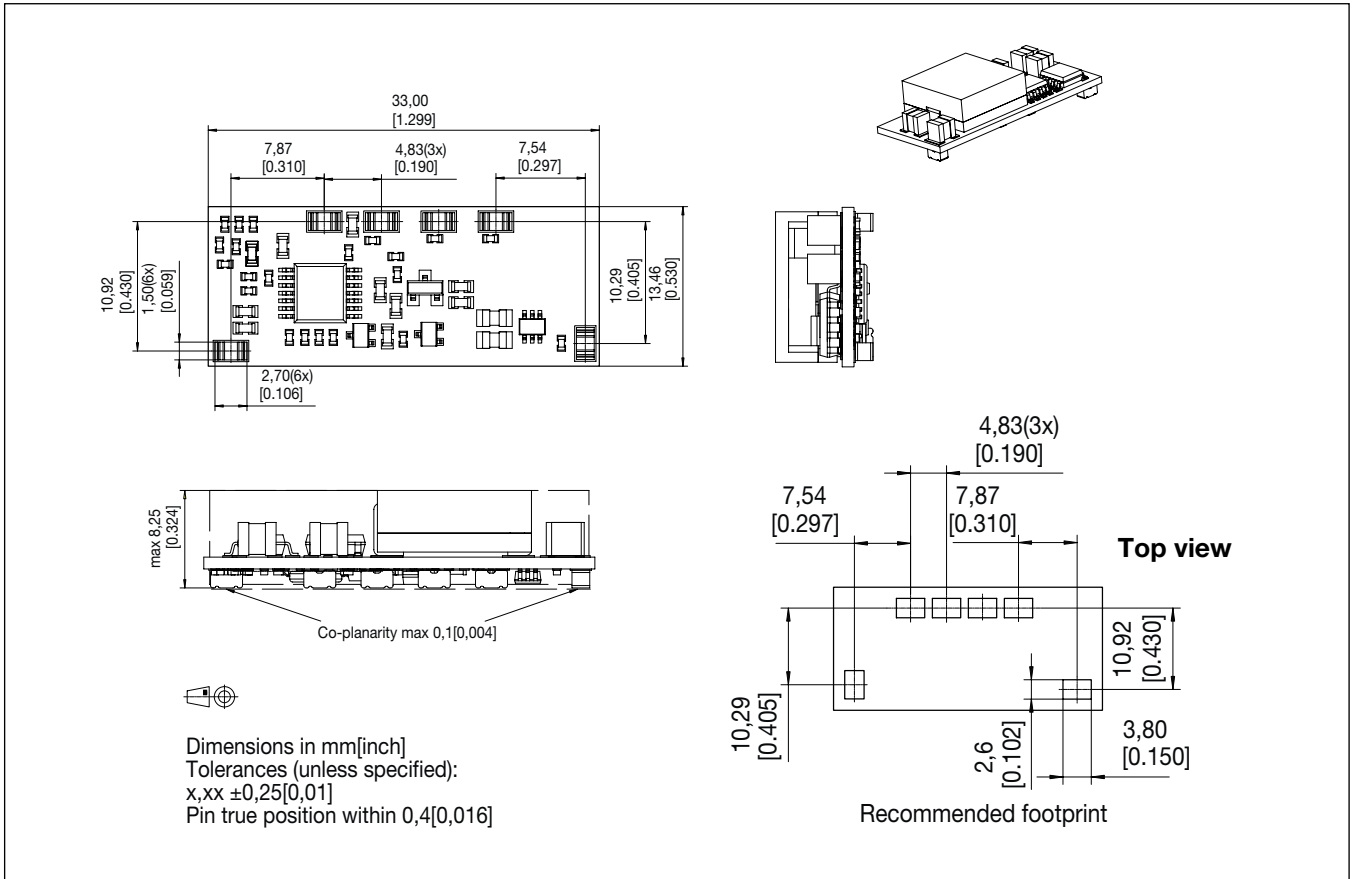

## Connections

Designation	Function
RC	Remote Control
+SENSE	Positive remote sense
Vadj	External output adjust
+OUT	Positive output
GND	Ground
+IN	Positive input

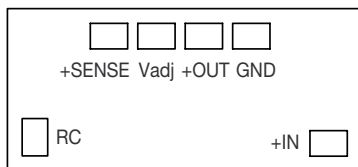

## Fundamental Circuit Diagram

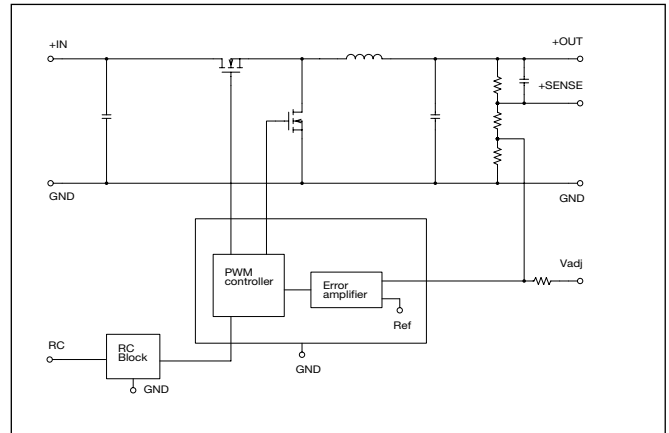

## Weight

7g

## Pins

Material: Copper

Plating: Matte tin over nickel

## PMC 4318T WS Output - Adjusted to 1.0 V out.

$T_{ref} = -30 \dots +90 \text{ }^\circ\text{C}$ ,  $V_I = 3.0 \dots 5.5 \text{ V}$  unless otherwise specified. Input filter  $2 \times 22 \text{ } \mu\text{F}$ , Output filter  $1 \times 150 \text{ } \mu\text{F}$   
 Typ values specified at:  $T_{ref} = +25 \text{ }^\circ\text{C}$  and  $V_{Inom}$ ,  $I_{Omax} = 10 \text{ A}$ . Note: +Sense connected to +Out

Characteristics		Conditions	Output			Unit
			min	typ	max	
$V_{O_i}$	Output voltage adjusted setting	$T_{ref} = +25 \text{ }^\circ\text{C}$ , $V_{Inom}$ , $I_{Omax}$ , $R_{adj} 80 \text{ k}\Omega$		1.00		V
	Output adjust range	$T_{ref} = +25 \text{ }^\circ\text{C}$ , $V_{Inom}$ , $I_{Omax}$	0.75		3.63	V
$V_O$	Output voltage tolerance band	$I_O = 0.01 \dots 1.0 \times I_{Omax}$	0.96		1.04	V
	Idling voltage	$I_O = 0$	0.97		1.03	V
	Line regulation	$V_{Imin} \dots V_{Imax}$ , $I_{Omax}$		11		mV
	Load regulation	$I_O = 0.01 \dots 1.0 \times I_{Omax}$ , $V_{Inom}$		10		mV
$V_{tr}$	Load transient voltage deviation	Load step = $0.25 \dots 0.75 \times I_{Omax}$ , $dI/dt = 10 \text{ A}/\mu\text{s}$		100		mV
$t_{tr}$	Load transient recovery time			55		$\mu\text{s}$
$T_{coeff}$	Temperature coefficient	$T_{ref} = -30 \dots +90 \text{ }^\circ\text{C}$ , $I_{Omax}$	-0.1	0	+0.1	mV/ $^\circ\text{C}$
$t_s$	Start-up time	From $V_I$ connected to $V_O = 0.9 \times V_{O_i}$ , $I_O = 0.1 \dots 1.0 \times I_{Omax}$ , $V_{Inom}$			1.7	ms
$t_r$	Ramp-up time	$0.1 \dots 0.9 \times V_O$ , $I_O = 0.1 \dots 1.0 \times I_{Omax}$ , $V_{Inom}$			1.1	ms
$t_f$	Fall time, $V_O \times 0.1$	$I_O = I_{Omax}$ , $V_{Inom}$			0.1	ms
$t_f$	Fall time, $V_O \times 0.1$	$I_O = 0 \text{ A}$ , $V_{Inom}$			5	s
$t_{RCoff}$	RC shut-down time to $V_O \times 0.1$	$I_O = I_{Omax}$ , $V_{Inom}$		0.25		ms
$t_{RCOn}$	RC start-up time to $V_O \times 0.9$	$I_O = I_{Omax}$ , $V_{Inom}$		0.9		ms
$t_{RC}$	RC fall time, $V_O \times 0.1 \dots 0.9$	$I_O = 0 \text{ A}$ , $V_{Inom}$		10		s
$I_O$	Output current		0		10	A
$P_{Omax}$	Max output power	At $V_O = V_{Onom}$	10			W
$I_{lim}$	Current limit threshold	$T_{ref} < T_{refmax}$	19	25	35	A
$V_{Oac}$	Output ripple	20 Hz ... 5 MHz, $I_{Omax}$		10	20	mV <sub>p-p</sub>

## Miscellaneous

$T_{ref} = -30 \dots +90 \text{ }^\circ\text{C}$ ,  $V_I = 3.0 \dots 5.5 \text{ V}$  unless otherwise specified. Input filter  $2 \times 22 \text{ } \mu\text{F}$ , Output filter  $1 \times 150 \text{ } \mu\text{F}$   
 Typ values specified at:  $T_{ref} = +25 \text{ }^\circ\text{C}$  and  $V_{Inom}$ ,  $I_{Omax} = 10 \text{ A}$ . Note: +Sense connected to +Out

Characteristics		Conditions	min	typ	max	Unit
$\eta$	Efficiency - 50% load	$I_O = 0.5 \times I_{Omax}$ , $V_I = 5 \text{ V}$		89		%
$\eta$	Efficiency - 100% load	$I_O = I_{Omax}$ , $V_I = 5 \text{ V}$	84.5	86.5		%
$P_d$	Power Dissipation	$I_O = I_{Omax}$ , $V_I = 5 \text{ V}$		1.6	2.0	W
$F_o$	Switching frequency	$I_O = 0 \dots 1.0 \times I_{Omax}$	260	300	340	kHz
$I_{sense}$	Remote sense current				8	mA
$I_I$	Static input current	$V_I = 3.0 \text{ V}$ , $I_O = I_{Omax}$ , $T_{ref} = 25 \text{ }^\circ\text{C}$		4.14		A
MTBF	Predicted reliability	$T_{ref} = 40 \text{ }^\circ\text{C}$		17		million hours

## PMC 4318T WS adjusted to 1.0 V out, Typical Characteristics

General conditions: Input filter 2 x 22  $\mu$ F, Output filter 1 x 150  $\mu$ F

### Efficiency

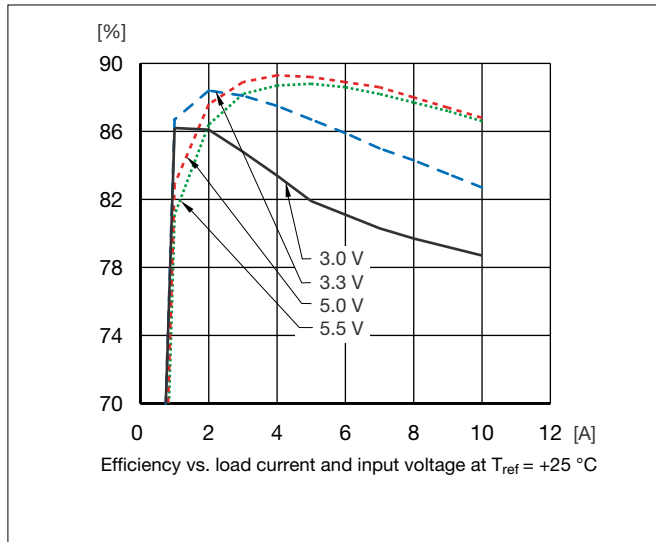

### Output Characteristics

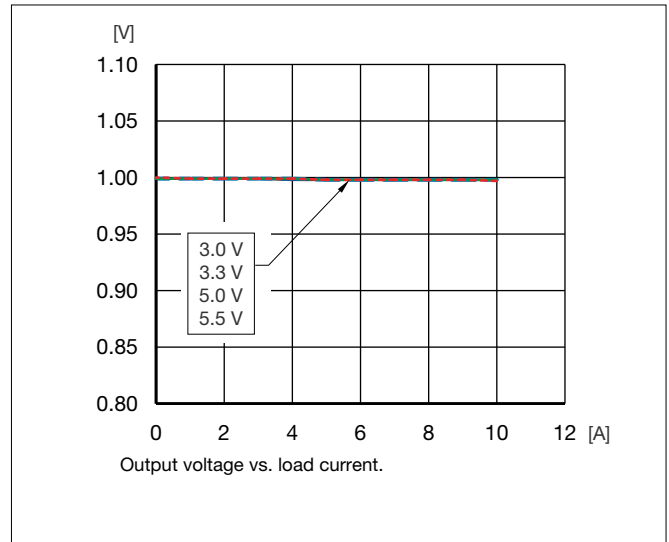

### Power Dissipation

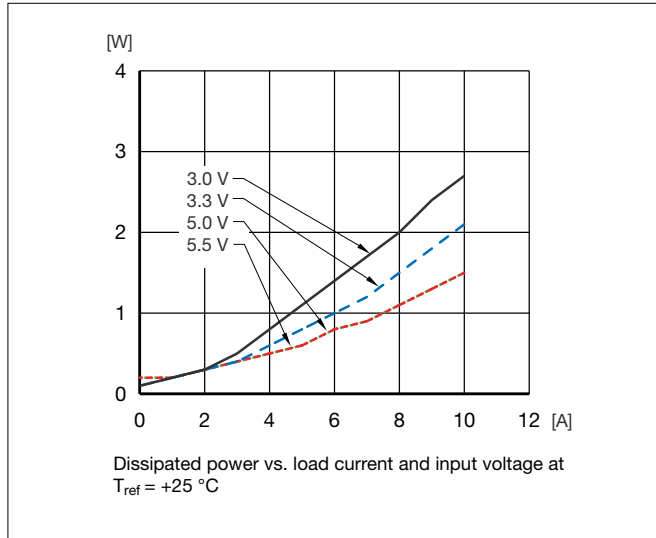

## PMC 4318T WS Output - Adjusted to 1.2 V out.

$T_{ref} = -30 \dots +90 \text{ }^\circ\text{C}$ ,  $V_I = 3.0 \dots 5.5 \text{ V}$  unless otherwise specified. Input filter  $2 \times 22 \text{ } \mu\text{F}$ , Output filter  $1 \times 150 \text{ } \mu\text{F}$   
 Typ values specified at:  $T_{ref} = +25 \text{ }^\circ\text{C}$  and  $V_{Inom}$ ,  $I_{Omax} = 10 \text{ A}$ . Note: +Sense connected to +Out

Characteristics		Conditions	Output			Unit
			min	typ	max	
$V_{O1}$	Output voltage adjusted setting	$T_{ref} = +25 \text{ }^\circ\text{C}$ , $V_{Inom}$ , $I_{Omax}$ , $R_{adj} 42 \text{ k}\Omega$		1.20		V
	Output adjust range	$T_{ref} = +25 \text{ }^\circ\text{C}$ , $V_{Inom}$ , $I_{Omax}$	0.75		3.63	V
$V_O$	Output voltage tolerance band	$I_O = 0.01 \dots 1.0 \times I_{Omax}$	1.15		1.25	V
	Idling voltage	$I_O = 0$	1.16		1.24	V
	Line regulation	$V_{Imin} \dots V_{Imax}$ , $I_{Omax}$		11		mV
	Load regulation	$I_O = 0.01 \dots 1.0 \times I_{Omax}$ , $V_{Inom}$		10		mV
$V_{tr}$	Load transient voltage deviation	Load step = $0.25 \dots 0.75 \times I_{Omax}$ , $dl/dt = 10 \text{ A}/\mu\text{s}$		100		mV
$t_{tr}$	Load transient recovery time			55		$\mu\text{s}$
$T_{coeff}$	Temperature coefficient	$T_{ref} = -30 \dots +90^\circ\text{C}$ , $I_{Omax}$	-0.1	0	+0.1	mV/ $^\circ\text{C}$
$t_s$	Start-up time	From $V_I$ connected to $V_O = 0.9 \times V_{O1}$ , $I_O = 0.1 \dots 1.0 \times I_{Omax}$ , $V_{Inom}$			1.7	ms
$t_r$	Ramp-up time	$0.1 \dots 0.9 \times V_O$ , $I_O = 0.1 \dots 1.0 \times I_{Omax}$ , $V_{Inom}$			1.1	ms
$t_f$	Fall time, $V_O \times 0.1$	$I_O = I_{Omax}$ , $V_{Inom}$			0.1	ms
$t_f$	Fall time, $V_O \times 0.1$	$I_O = 0 \text{ A}$ , $V_{Inom}$			5	s
$t_{RCoff}$	RC shut-down time to $V_O \times 0.1$	$I_O = I_{Omax}$ , $V_{Inom}$		0.25		ms
$t_{RCOn}$	RC start-up time to $V_O \times 0.9$	$I_O = I_{Omax}$ , $V_{Inom}$		0.9		ms
$t_{RC}$	RC fall time, $V_O \times 0.1 \dots 0.9$	$I_O = 0 \text{ A}$ , $V_{Inom}$		5		s
$I_O$	Output current		0		10	A
$P_{Omax}$	Max output power	At $V_O = V_{Onom}$	12			W
$I_{lim}$	Current limit threshold	$T_{ref} < T_{refmax}$	19	25	35	A
$V_{Oac}$	Output ripple	20 Hz ... 5 MHz, $I_{Omax}$		10	20	mV <sub>p-p</sub>

## Miscellaneous

$T_{ref} = -30 \dots +90 \text{ }^\circ\text{C}$ ,  $V_I = 3.0 \dots 5.5 \text{ V}$  unless otherwise specified. Input filter  $2 \times 22 \text{ } \mu\text{F}$ , Output filter  $1 \times 150 \text{ } \mu\text{F}$   
 Typ values specified at:  $T_{ref} = +25 \text{ }^\circ\text{C}$  and  $V_{Inom}$ ,  $I_{Omax} = 10 \text{ A}$ . Note: +Sense connected to +Out

Characteristics		Conditions	min	typ	max	Unit
$\eta$	Efficiency - 50% load	$I_O = 0.5 \times I_{Omax}$ , $V_I = 5 \text{ V}$		90.5		%
$\eta$	Efficiency - 100% load	$I_O = I_{Omax}$ , $V_I = 5 \text{ V}$	86.5	88.5		%
$P_d$	Power Dissipation	$I_O = I_{Omax}$ , $V_I = 5 \text{ V}$		1.5	2.0	W
$F_o$	Switching frequency	$I_O = 0 \dots 1.0 \times I_{Omax}$	260	300	340	kHz
$I_{sense}$	Remote sense current				8	mA
$I_I$	Static input current	$V_I = 3.0 \text{ V}$ , $I_O = I_{Omax}$ , $T_{ref} = 25 \text{ }^\circ\text{C}$		4.79		A
MTBF	Predicted reliability	$T_{ref} = 40 \text{ }^\circ\text{C}$		17		million hours

## PMC 4318T WS adjusted to 1.2 V, Typical Characteristics

General conditions: Input filter 2 x 22  $\mu$ F, Output filter 1 x 150  $\mu$ F

### Efficiency

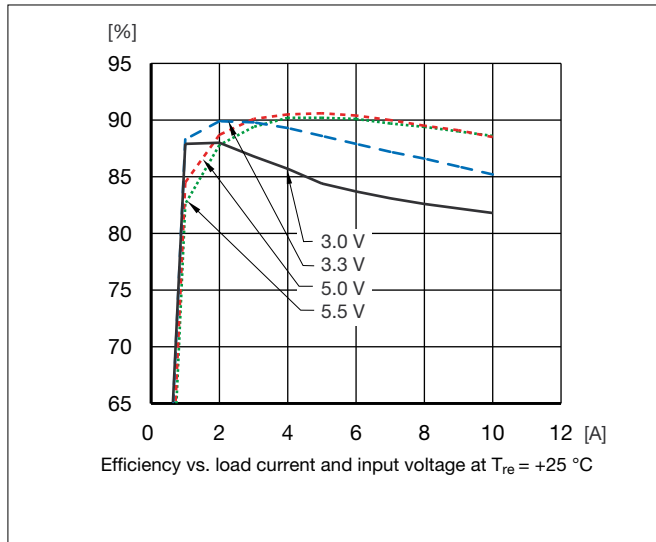

### Output Characteristic

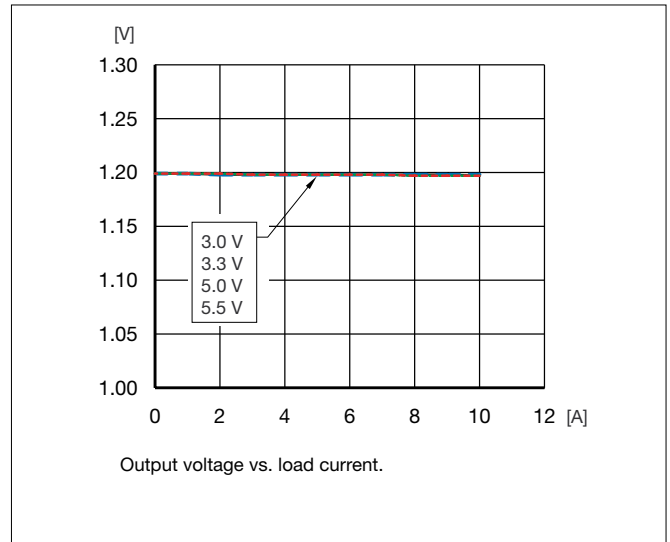

### Power Dissipation

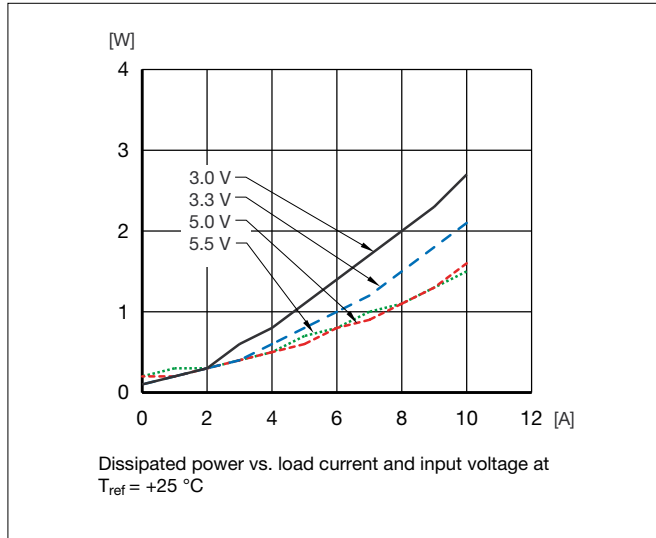

## PMC 4318T WS Output - Adjusted to 1.5 V out.

$T_{ref} = -30 \dots +90 \text{ }^\circ\text{C}$ ,  $V_I = 3.0 \dots 5.5 \text{ V}$  unless otherwise specified. Input filter  $2 \times 22 \text{ } \mu\text{F}$ , Output filter  $1 \times 150 \text{ } \mu\text{F}$   
Typ values specified at:  $T_{ref} = +25 \text{ }^\circ\text{C}$  and  $V_{Inom}$ ,  $I_{Omax} = 10 \text{ A}$ . Note: +Sense connected to +Out

Characteristics		Conditions	Output			Unit
			min	typ	max	
$V_{O_i}$	Output voltage adjusted setting	$T_{ref} = +25 \text{ }^\circ\text{C}$ , $V_{Inom}$ , $I_{Omax}$ , $R_{adj} 23 \text{ k}\Omega$		1.5		V
	Output adjust range	$T_{ref} = +25 \text{ }^\circ\text{C}$ , $V_{Inom}$ , $I_{Omax}$	0.75		3.63	V
$V_O$	Output voltage tolerance band	$I_O = 0.01 \dots 1.0 \times I_{Omax}$	1.44		1.56	V
	Idling voltage	$I_O = 0$	1.45		1.55	V
	Line regulation	$V_{Imin} \dots V_{Imax}$ , $I_{Omax}$		11		mV
	Load regulation	$I_O = 0.01 \dots 1.0 \times I_{Omax}$ , $V_{Inom}$		10		mV
$V_{tr}$	Load transient voltage deviation	Load step = $0.25 \dots 0.75 \times I_{Omax}$ , $dI/dt = 10 \text{ A}/\mu\text{s}$		100		mV
$t_{tr}$	Load transient recovery time			55		$\mu\text{s}$
$T_{coeff}$	Temperature coefficient	$T_{ref} = -30 \dots +90 \text{ }^\circ\text{C}$ , $I_{Omax}$	-0.1	0	+0.1	$\text{mV}/^\circ\text{C}$
$t_s$	Start-up time	From $V_I$ connected to $V_O = 0.9 \times V_{O_i}$ , $I_O = 0.1 \dots 1.0 \times I_{Omax}$ , $V_{Inom}$			1.7	ms
$t_r$	Ramp-up time	$0.1 \dots 0.9 \times V_O$ , $I_O = 0.1 \dots 1.0 \times I_{Omax}$ , $V_{Inom}$			1.1	ms
$t_f$	Fall time, $V_O \times 0.1$	$I_O = I_{Omax}$ , $V_{Inom}$			0.1	ms
$t_f$	Fall time, $V_O \times 0.1$	$I_O = 0 \text{ A}$ , $V_{Inom}$			5	s
$t_{RCoff}$	RC shut-down time to $V_O \times 0.1$	$I_O = I_{Omax}$ , $V_{Inom}$		0.25		ms
$t_{RCOn}$	RC start-up time to $V_O \times 0.9$	$I_O = I_{Omax}$ , $V_{Inom}$		0.9		ms
$t_{RC}$	RC fall time, $V_O \times 0.1 \dots 0.9$	$I_O = 0 \text{ A}$ , $V_{Inom}$		5		s
$I_O$	Output current		0		10	A
$P_{Omax}$	Max output power	At $V_O = V_{Onom}$	15			W
$I_{lim}$	Current limit threshold	$T_{ref} < T_{refmax}$	19	25	35	A
$V_{Oac}$	Output ripple	20Hz ... 5MHz, $I_{Omax}$		15	25	$\text{mV}_{p-p}$

## Miscellaneous

$T_{ref} = -30 \dots +90 \text{ }^\circ\text{C}$ ,  $V_I = 3.0 \dots 5.5 \text{ V}$  unless otherwise specified. Input filter  $2 \times 22 \text{ } \mu\text{F}$ , Output filter  $1 \times 150 \text{ } \mu\text{F}$   
Typ values specified at:  $T_{ref} = +25 \text{ }^\circ\text{C}$  and  $V_{Inom}$ ,  $I_{Omax} = 10 \text{ A}$ . Note: +Sense connected to +Out

Characteristics		Conditions	min	typ	max	Unit
$\eta$	Efficiency - 50% load	$I_O = 0.5 \times I_{Omax}$ , $V_I = 5 \text{ V}$		92		%
$\eta$	Efficiency - 100% load	$I_O = I_{Omax}$ , $V_I = 5 \text{ V}$	88	90		%
$P_d$	Power Dissipation	$I_O = I_{Omax}$ , $V_I = 5 \text{ V}$		1.6	2.2	W
$F_o$	Switching frequency	$I_O = 0 \dots 1.0 \times I_{Omax}$	260	300	340	kHz
$I_{sense}$	Remote sense current				8	mA
$I_i$	Static input current	$V_I = 3.0 \text{ V}$ , $I_O = I_{Omax}$ , $T_{ref} = 25 \text{ }^\circ\text{C}$		5.78		A
MTBF	Predicted reliability	$T_{ref} = 40 \text{ }^\circ\text{C}$		17		million hours



# PMC 4318T WS adjusted to 1.5V out, Typical Characteristics

General conditions: Input filter 2 x 22  $\mu$ F, Output filter 1 x 150  $\mu$ F

## Efficiency

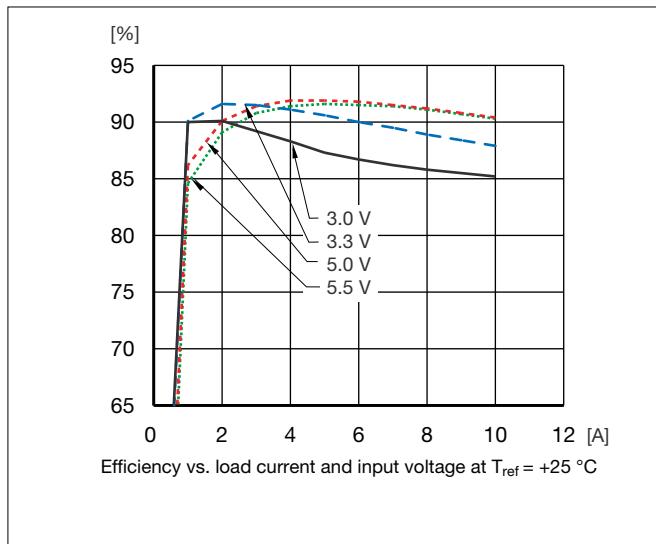

## Output Characteristic

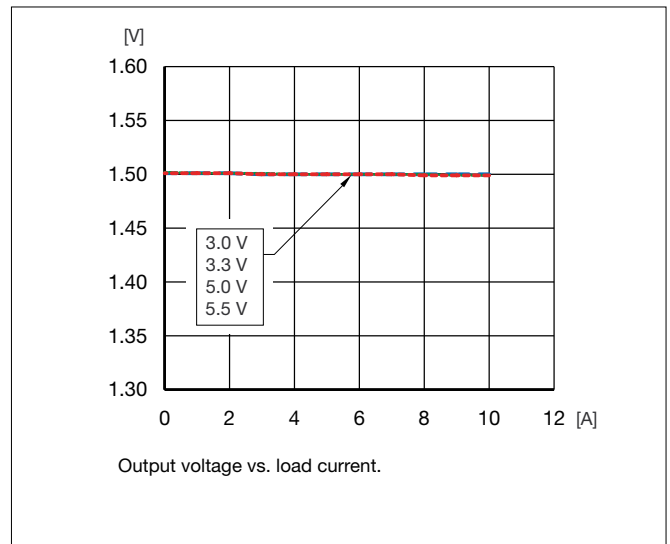

## Power Dissipation

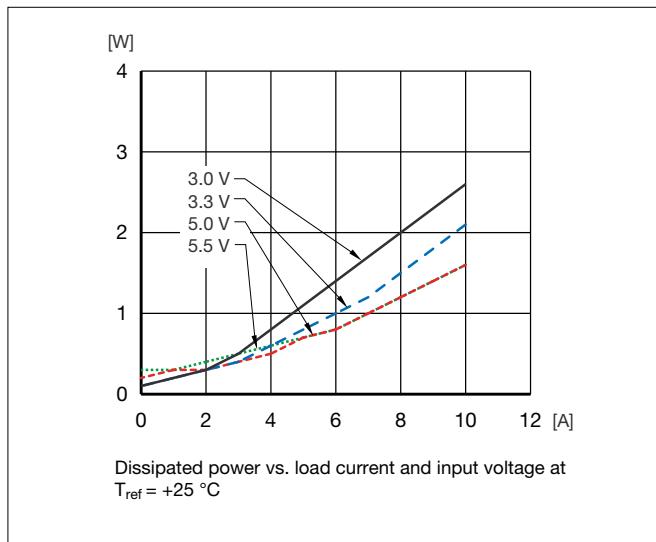

## PMC 4318T WS Output - Adjusted to 1.8 V out.

$T_{ref} = -30...+90\text{ }^{\circ}\text{C}$ ,  $V_I = 3.0 \dots 5.5\text{ V}$  unless otherwise specified. Input filter  $2 \times 22\text{ }\mu\text{F}$ , Output filter  $1 \times 150\text{ }\mu\text{F}$   
Typ values specified at:  $T_{ref} = +25\text{ }^{\circ}\text{C}$  and  $V_{Inom}$ ,  $I_{Omax} = 10\text{ A}$ . Note: +Sense connected to +Out

Characteristics		Conditions	Output			Unit
			min	typ	max	
$V_{O_i}$	Output voltage adjusted setting	$T_{ref} = +25\text{ }^{\circ}\text{C}$ , $V_{Inom}$ , $I_{Omax}$ , $R_{adj} 15\text{ k}\Omega$		1.80		V
	Output adjust range	$T_{ref} = +25\text{ }^{\circ}\text{C}$ , $V_{Inom}$ , $I_{Omax}$	0.75		3.63	V
$V_O$	Output voltage tolerance band	$I_O = 0.01...1.0 \times I_{Omax}$	1.73		1.87	V
	Idling voltage	$I_O = 0$	1.75		1.85	V
	Line regulation	$V_{Imin} \dots V_{Imax}$ , $I_{Omax}$		11		mV
	Load regulation	$I_O = 0.01...1.0 \times I_{Omax}$ , $V_{Inom}$		10		mV
$V_{tr}$	Load transient voltage deviation	Load step = $0.25 \dots 0.75 \times I_{Omax}$ , $di/dt = 10\text{ A}/\mu\text{s}$		70		mV
$t_{tr}$	Load transient recovery time			55		$\mu\text{s}$
$T_{coeff}$	Temperature coefficient	$T_{ref} = -30 \dots +90\text{ }^{\circ}\text{C}$ , $I_{Omax}$	-0.1	0	+0.1	mV/ $^{\circ}\text{C}$
$t_s$	Start-up time	From $V_I$ connected to $V_O = 0.9 \times V_{O_i}$ , $I_O = 0.1 \dots 1.0 \times I_{Omax}$ , $V_{Inom}$			1.7	ms
$t_r$	Ramp-up time	$0.1...0.9 \times V_O$ , $I_O = 0.1 \dots 1.0 \times I_{Omax}$ , $V_{Inom}$			1.1	ms
$t_f$	Fall time, $V_O \times 0.1$	$I_O = I_{Omax}$ , $V_{Inom}$			0.1	ms
$t_f$	Fall time, $V_O \times 0.1$	$I_O = 0\text{ A}$ , $V_{Inom}$			5	s
$t_{RCoff}$	RC shut-down time to $V_O \times 0.1$	$I_O = I_{Omax}$ , $V_{Inom}$		0.25		ms
$t_{RCOn}$	RC start-up time to $V_O \times 0.9$	$I_O = I_{Omax}$ , $V_{Inom}$		0.9		ms
$t_{RC}$	RC fall time, $V_O \times 0.1 \dots 0.9$	$I_O = 0\text{ A}$ , $V_{Inom}$		5		s
$I_O$	Output current		0		10	A
$P_{Omax}$	Max output power	At $V_O = V_{Onom}$	18			W
$I_{lim}$	Current limit threshold	$T_{ref} < T_{refmax}$	19	25	35	A
$V_{Oac}$	Output ripple	20 Hz ... 5 MHz, $I_{Omax}$		15	25	mV <sub>p-p</sub>

## Miscellaneous

$T_{ref} = -30...+90\text{ }^{\circ}\text{C}$ ,  $V_I = 3.0 \dots 5.5\text{ V}$  unless otherwise specified. Input filter  $2 \times 22\text{ }\mu\text{F}$ , Output filter  $1 \times 150\text{ }\mu\text{F}$   
Typ values specified at:  $T_{ref} = +25\text{ }^{\circ}\text{C}$  and  $V_{Inom}$ ,  $I_{Omax} = 10\text{ A}$ . Note: +Sense connected to +Out

Characteristics		Conditions	min	typ	max	Unit
$\eta$	Efficiency - 50% load	$I_O = 0.5 \times I_{Omax}$ , $V_I = 5\text{ V}$		92.5		%
$\eta$	Efficiency - 100% load	$I_O = I_{Omax}$ , $V_I = 5\text{ V}$	90	91.5		%
$P_d$	Power Dissipation	$I_O = I_{Omax}$ , $V_I = 5\text{ V}$		1.6	2.1	W
$F_o$	Switching frequency	$I_O = 0 \dots 1.0 \times I_{Omax}$	260	300	340	kHz
$I_{sense}$	Remote sense current				8	mA
$I_I$	Static input current	$V_I = 3.0\text{ V}$ , $I_O = I_{Omax}$ , $T_{ref} = 25\text{ }^{\circ}\text{C}$		6.77		A
MTBF	Predicted reliability	$T_{ref} = 40\text{ }^{\circ}\text{C}$		17		million hours

# PMC 4318T WS adjusted to 1.8 V, Typical Characteristics

General conditions: Input filter 2 x 22  $\mu$ F, Output filter 1 x 150  $\mu$ F

## Efficiency

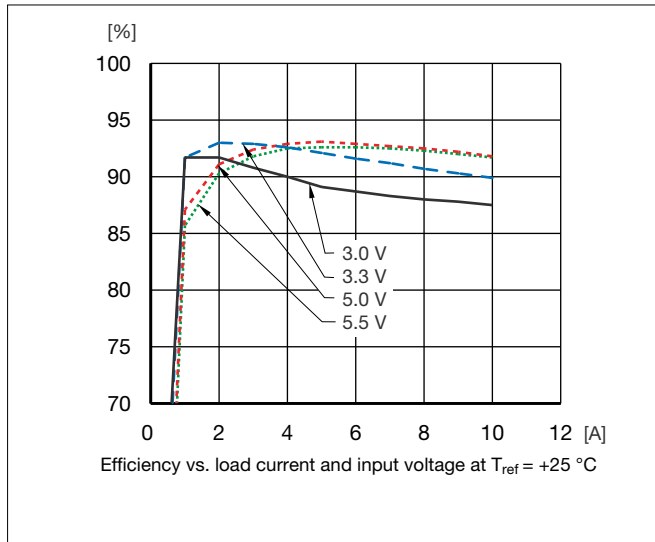

## Power Dissipation

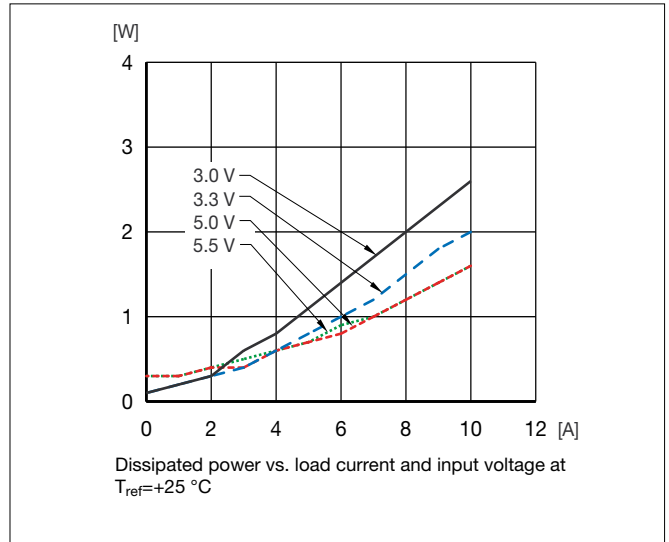

## Output Current Derating at 3.3 V input

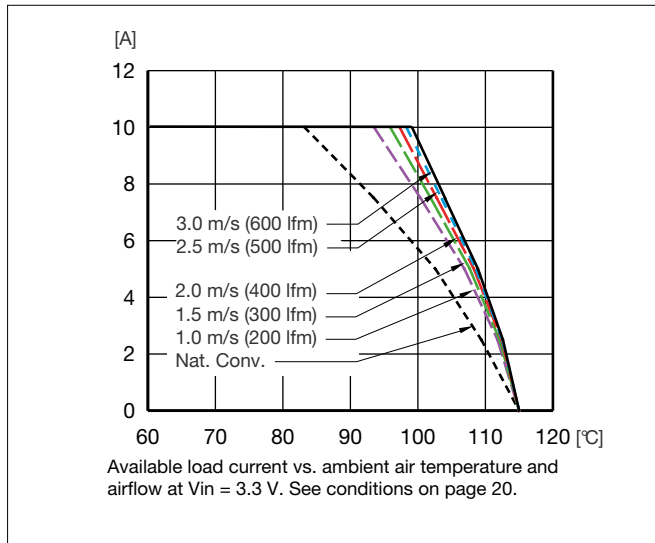

## Output Current Derating at 5 V input

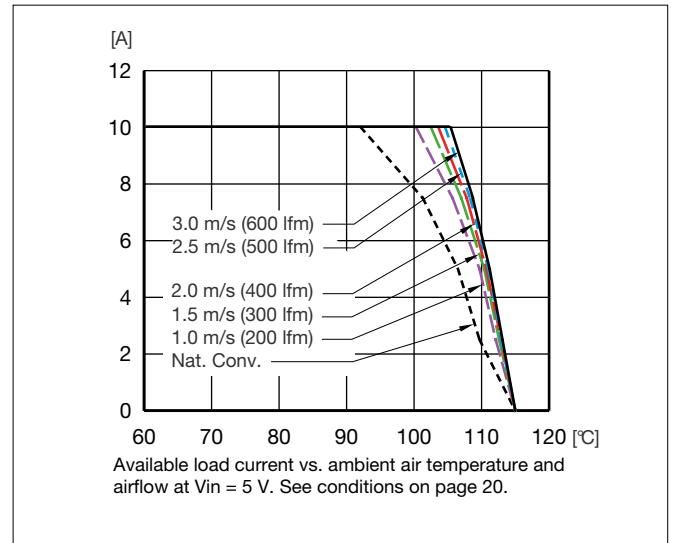

## Output Characteristic

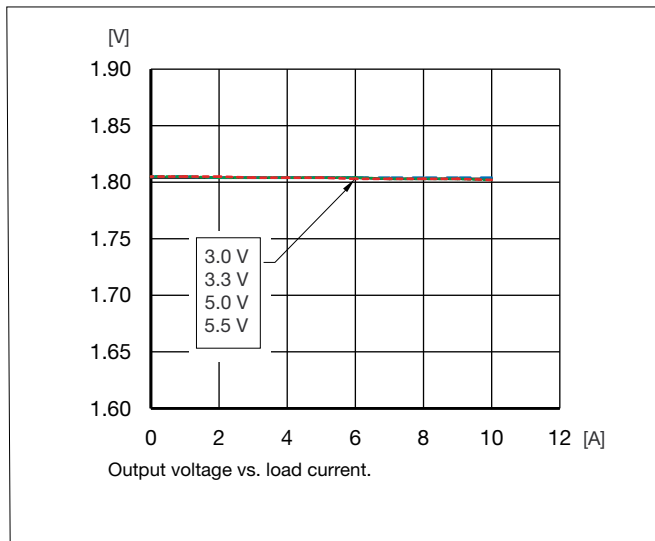

## Start-Up

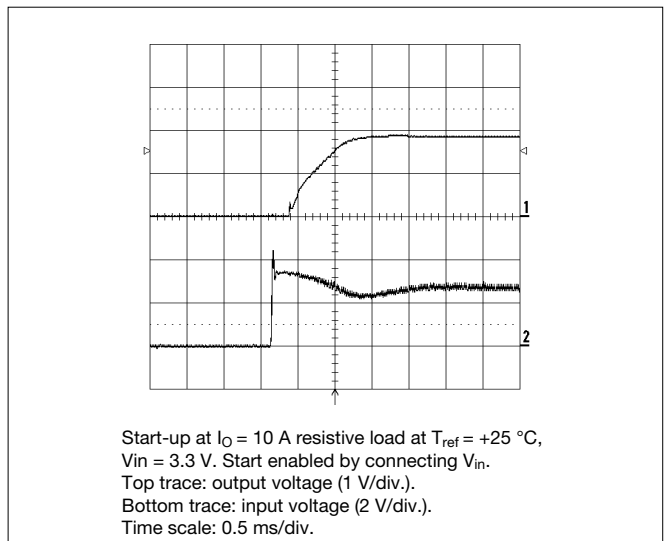

## PMC 4318T WS adjusted to 1.8 V out, Typical Characteristics

General conditions: Input filter 2 x 22  $\mu$ F, Output filter 1 x 150  $\mu$ F

### Turn Off

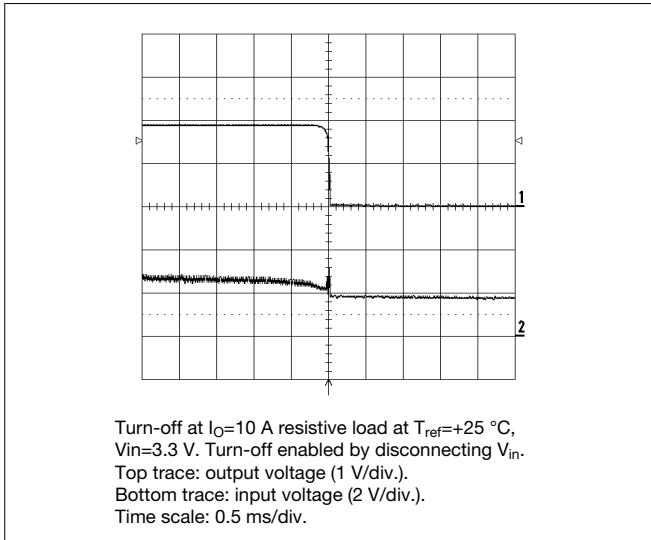

### Output Ripple

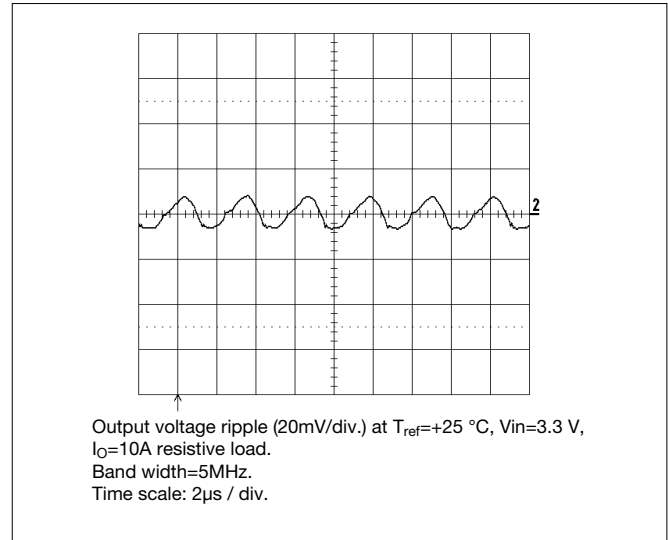

### Transient with 150 $\mu$ F output capacitor

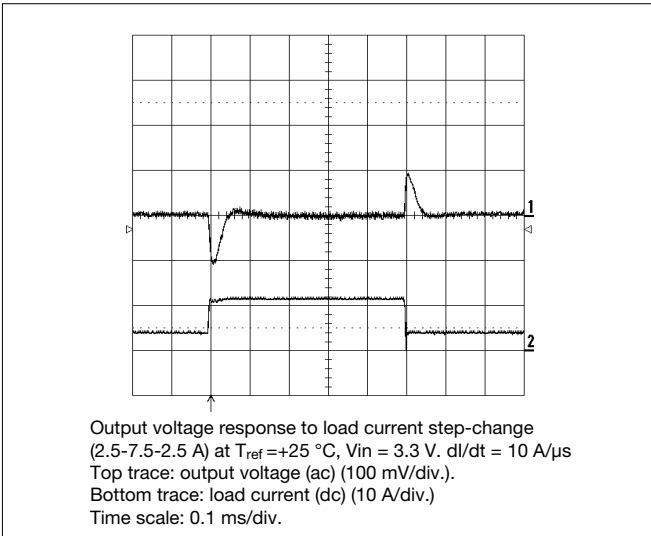

### Transient with 300 $\mu$ F output capacitor

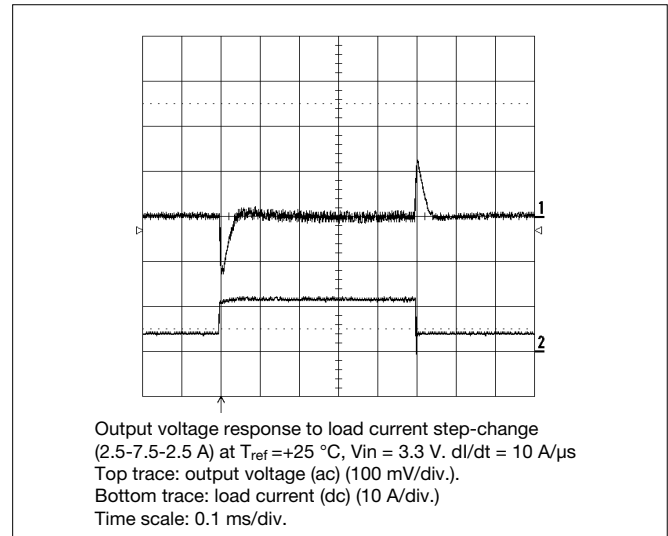

## PMC 4318T WS Output - Adjusted to 2.5 V out.

$T_{ref} = -30 \dots +90 \text{ }^\circ\text{C}$ ,  $V_I = 3.0 \dots 5.5 \text{ V}$  unless otherwise specified. Input filter  $2 \times 22 \text{ } \mu\text{F}$ , Output filter  $1 \times 150 \text{ } \mu\text{F}$   
Typ values specified at:  $T_{ref} = +25 \text{ }^\circ\text{C}$  and  $V_{Inom}$ ,  $I_{Omax} = 10 \text{ A}$ . Note: +Sense connected to +Out

Characteristics		Conditions	Output			Unit
			min	typ	max	
$V_{O_i}$	Output voltage adjusted setting	$T_{ref} = +25 \text{ }^\circ\text{C}$ , $V_{Inom}$ , $I_{Omax}$ , $R_{adj} 7 \text{ k}\Omega$		2.5		V
	Output adjust range	$T_{ref} = +25 \text{ }^\circ\text{C}$ , $V_{Inom}$ , $I_{Omax}$	0.75		3.63	V
$V_O$	Output voltage tolerance band	$I_O = 0.01 \dots 1.0 \times I_{Omax}$	2.40		2.60	V
	Idling voltage	$I_O = 0$	2.42		2.58	V
	Line regulation	$V_{Imin} \dots V_{Imax}$ , $I_{Omax}$		11		mV
	Load regulation	$I_O = 0.01 \dots 1.0 \times I_{Omax}$ , $V_{Inom}$		10		mV
$V_{tr}$	Load transient voltage deviation	Load step = $0.25 \dots 0.75 \times I_{Omax}$ , $dI/dt = 10 \text{ A}/\mu\text{s}$		100		mV
$t_{tr}$	Load transient recovery time			55		$\mu\text{s}$
$T_{coeff}$	Temperature coefficient	$T_{ref} = -30 \dots +90 \text{ }^\circ\text{C}$ , $I_{Omax}$	-0.1	0	+0.1	mV/ $^\circ\text{C}$
$t_s$	Start-up time	From $V_I$ connected to $V_O = 0.9 \times V_{O_i}$ , $I_O = 0.1 \dots 1.0 \times I_{Omax}$ , $V_{Inom}$			1.7	ms
$t_r$	Ramp-up time	$0.1 \dots 0.9 \times V_O$ , $I_O = 0.1 \dots 1.0 \times I_{Omax}$ , $V_{Inom}$			1.1	ms
$t_f$	Fall time, $V_O \times 0.1$	$I_O = I_{Omax}$ , $V_{Inom}$			0.1	ms
$t_f$	Fall time, $V_O \times 0.1$	$I_O = 0 \text{ A}$ , $V_{Inom}$			5	s
$t_{RCoff}$	RC shut-down time to $V_O \times 0.1$	$I_O = I_{Omax}$ , $V_{Inom}$		0.25		ms
$t_{RCOn}$	RC start-up time to $V_O \times 0.9$	$I_O = I_{Omax}$ , $V_{Inom}$		0.9		ms
$t_{RC}$	RC fall time, $V_O \times 0.1 \dots 0.9$	$I_O = 0 \text{ A}$ , $V_{Inom}$		5		s
$I_O$	Output current		0		10	A
$P_{Omax}$	Max output power	At $V_O = V_{Onom}$	25			W
$I_{lim}$	Current limit threshold	$T_{ref} < T_{refmax}$	19	25	35	A
$V_{Oac}$	Output ripple	20 Hz ... 5 MHz, $I_{Omax}$		20	30	mV <sub>p-p</sub>

## Miscellaneous

$T_{ref} = -30 \dots +90 \text{ }^\circ\text{C}$ ,  $V_I = 3.0 \dots 5.5 \text{ V}$  unless otherwise specified. Input filter  $2 \times 22 \text{ } \mu\text{F}$ , Output filter  $1 \times 150 \text{ } \mu\text{F}$   
Typ values specified at:  $T_{ref} = +25 \text{ }^\circ\text{C}$  and  $V_{Inom}$ ,  $I_{Omax} = 10 \text{ A}$ . Note: +Sense connected to +Out

Characteristics		Conditions	min	typ	max	Unit
$\eta$	Efficiency - 50% load	$I_O = 0.5 \times I_{Omax}$ , $V_I = 5 \text{ V}$		95		%
$\eta$	Efficiency - 100% load	$I_O = I_{Omax}$ , $V_I = 5 \text{ V}$	92	94		%
$P_d$	Power Dissipation	$I_O = I_{Omax}$ , $V_I = 5 \text{ V}$		1.6	2.5	W
$F_o$	Switching frequency	$I_O = 0 \dots 1.0 \times I_{Omax}$	260	300	340	kHz
$I_{sense}$	Remote sense current				8	mA
$I_I$	Static input current	$V_I = 3.0 \text{ V}$ , $I_O = I_{Omax}$ , $T_{ref} = 25 \text{ }^\circ\text{C}$		9.02		A
MTBF	Predicted reliability	$T_{ref} = 40 \text{ }^\circ\text{C}$		17		million hours

## PMC 4318T WS adjusted to 2.5 V out, Typical Characteristics

General conditions: Input filter 2 x 22  $\mu$ F, Output filter 1 x 150  $\mu$ F

### Efficiency

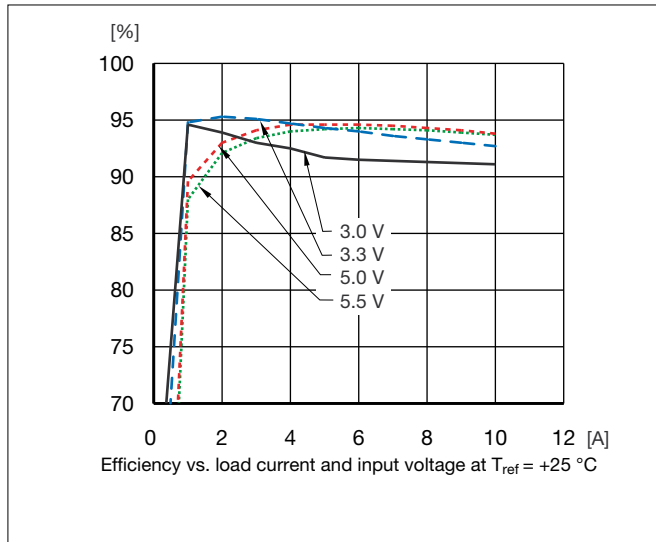

### Output Characteristic

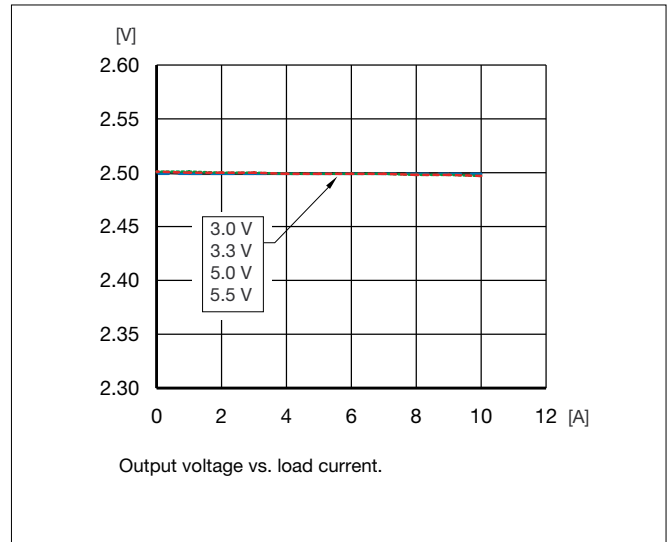

### Power Dissipation

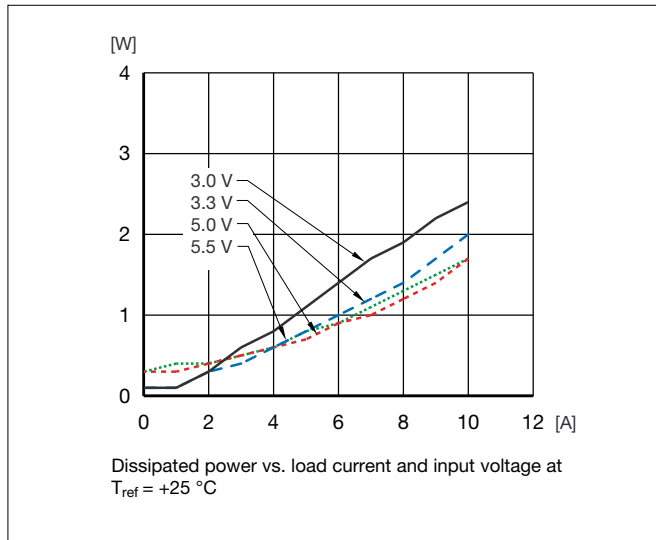

## PMC 4318T WS Output - Adjusted to 3.3 V out.

$T_{ref} = -30 \dots +90 \text{ }^\circ\text{C}$ ,  $V_I = 3.6 \dots 5.5 \text{ V}$  unless otherwise specified. Input filter  $2 \times 22 \text{ } \mu\text{F}$ , Output filter  $1 \times 150 \text{ } \mu\text{F}$   
Typ values specified at:  $T_{ref} = +25 \text{ }^\circ\text{C}$  and  $V_{Inom}$ ,  $I_{Omax} = 10 \text{ A}$ . Note: +Sense connected to +Out

Characteristics		Conditions	Output			Unit
			min	typ	max	
$V_{O_i}$	Output voltage adjusted setting	$T_{ref} = +25 \text{ }^\circ\text{C}$ , $V_I > 3.6 \text{ V}$ , $I_{Omax}$ , $R_{adj} 3.1 \text{ k}\Omega$		3.3		V
	Output adjust range	$T_{ref} = +25 \text{ }^\circ\text{C}$ , $V_{Inom}$ , $I_{Omax}$	0.75		3.63	V
$V_O$	Output voltage tolerance band	$I_O = 0.01 \dots 1.0 \times I_{Omax}$	3.17		3.43	V
	Idling voltage	$I_O = 0$	3.20		3.40	V
	Line regulation	$V_I = 5 \text{ V} \dots V_{Imax}$ , $I_{Omax}$		11		mV
	Load regulation	$I_O = 0.01 \dots 1.0 \times I_{Omax}$ , $V_I = 5 \text{ V}$		10		mV
$V_{tr}$	Load transient voltage deviation	Load step = $0.25 \dots 0.75 \times I_{Omax}$ , $dl/dt = 10 \text{ A}/\mu\text{s}$		100		mV
$t_{tr}$	Load transient recovery time			55		$\mu\text{s}$
$T_{coeff}$	Temperature coefficient	$T_{ref} = -30 \dots +90 \text{ }^\circ\text{C}$ , $I_{Omax}$	-0.1	0	+0.1	mV/ $^\circ\text{C}$
$t_s$	Start-up time	From $V_I$ connected to $V_O = 0.9 \times V_{Oadj}$ , $I_O = 0.1 \dots 1.0 \times I_{Omax}$ , $V_I = 5 \text{ V}$			1.7	ms
$t_r$	Ramp-up time	$0.1 \dots 0.9 \times V_O$ , $I_O = 0.1 \dots 1.0 \times I_{Omax}$ , $V_I = 5 \text{ V}$			1.1	ms
$t_f$	Fall time, $V_O \times 0.1$	$I_O = I_{Omax}$ , $V_I = 5 \text{ V}$			0.1	ms
$t_f$	Fall time, $V_O \times 0.1$	$I_O = 0 \text{ A}$ , $V_I = 5 \text{ V}$			5	s
$t_{RCoff}$	RC shut-down time to $V_O \times 0.1$	$I_O = I_{Omax}$ , $V_I = 5 \text{ V}$		0.25		ms
$t_{RCOn}$	RC start-up time to $V_O \times 0.9$	$I_O = I_{Omax}$ , $V_I = 5 \text{ V}$		0.9		ms
$t_{RC}$	RC fall time, $V_O \times 0.1 \dots 0.9$	$I_O = 0 \text{ A}$ , $V_I = 5 \text{ V}$		5		s
$I_O$	Output current		0		10	A
$P_{Omax}$	Max output power	At $V_O = V_{Onom}$	33			W
$I_{lim}$	Current limit threshold	$T_{ref} < T_{refmax}$	19	25	35	A
$V_{Oac}$	Output ripple	20 Hz ... 5 MHz, $I_{Omax}$		20	30	mV <sub>p-p</sub>

## Miscellaneous

$T_{ref} = -30 \dots +90 \text{ }^\circ\text{C}$ ,  $V_I = 3.6 \dots 5.5 \text{ V}$  unless otherwise specified. Input filter  $2 \times 22 \text{ } \mu\text{F}$ , Output filter  $1 \times 150 \text{ } \mu\text{F}$   
Typ values specified at:  $T_{ref} = +25 \text{ }^\circ\text{C}$  and  $V_{Inom}$ ,  $I_{Omax} = 10 \text{ A}$ . Note: +Sense connected to +Out

Characteristics		Conditions	min	typ	max	Unit
$\eta$	Efficiency - 50% load	$I_O = 0.5 \times I_{Omax}$ , $V_I = 5 \text{ V}$		96		%
$\eta$	Efficiency - 100% load	$I_O = I_{Omax}$ , $V_I = 5 \text{ V}$	93	95.5		%
$P_d$	Power Dissipation	$I_O = I_{Omax}$ , $V_I = 5 \text{ V}$		1.6	2.6	W
$F_o$	Switching frequency	$I_O = 0 \dots 1.0 \times I_{Omax}$	260	300	340	kHz
$I_{sense}$	Remote sense current				8	mA
$I_I$	Static input current	$V_I = 3.6 \text{ V}$ , $I_O = I_{Omax}$ , $T_{ref} = 25 \text{ }^\circ\text{C}$		10		A
MTBF	Predicted reliability	$T_{ref} = 40 \text{ }^\circ\text{C}$		17		million hours

## PMC 4318T WS adjusted to 3.3 V, Typical Characteristics

General conditions: Input filter 2 x 22  $\mu$ F, Output filter 1 x 150  $\mu$ F

### Efficiency

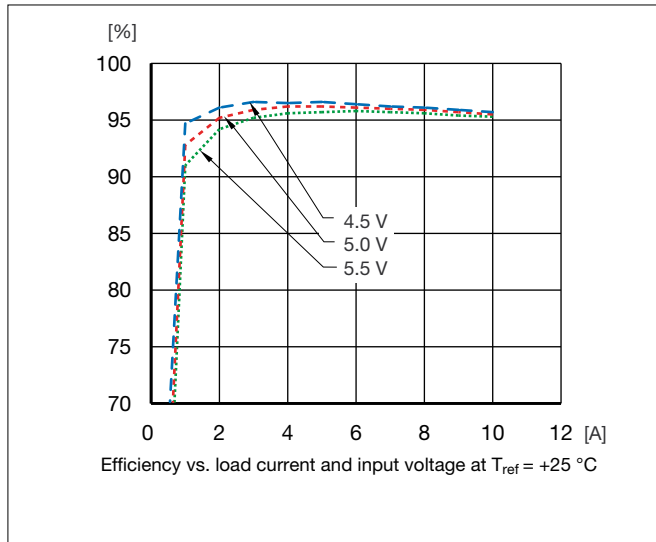

### Output Characteristic

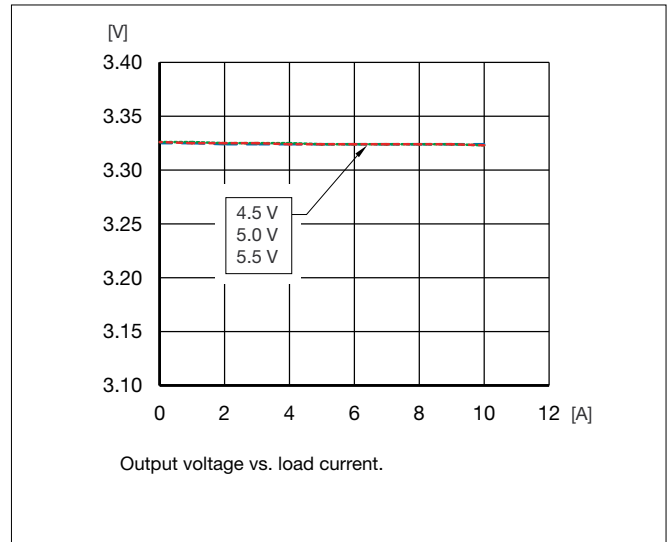

### Power Dissipation

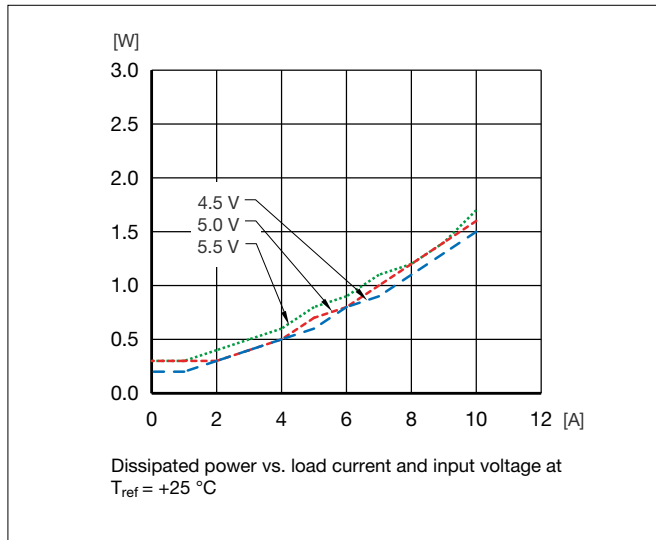



## EMC Specification

### Layout Recommendation

The radiated EMI performance of the DC/DC regulator will be optimised by including a ground plane in the PCB area under the DC/DC regulator. This approach will return switching noise to ground as directly as possible, with improvements to both emission and susceptibility.

## Operating Information

### Remote Control (RC)

The RC pin may be used to turn on or turn off the regulator using a suitable open collector function.

Turn off is achieved by connecting the RC pin to ground.

The regulator will run in normal operation when the RC pin is left open.

RC	Regulator condition	min	typ	max	Unit
Low level referenced to GND	OFF	0		0.3	V
Open	ON				

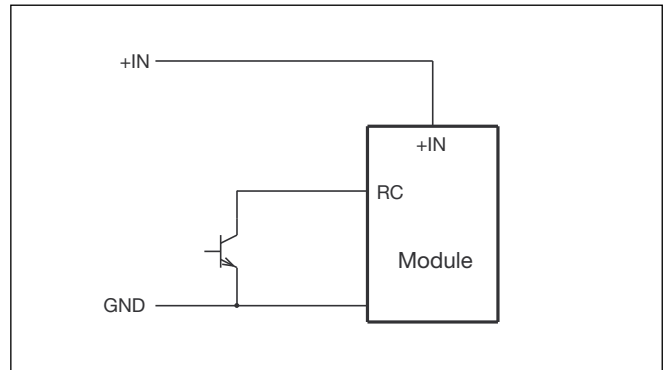

### Remote Sense

All PMC 4000 Series DC/DC regulators have a positive remote sense pin that can be used to compensate for moderate amounts of resistance in the distribution system and allow for voltage regulation at the load or other selected point. The remote sense line will carry very little current and does not need a large cross sectional area. However, the sense line on the PCB should be located close to a ground trace or ground plane. The remote sense circuitry will compensate for up to 10% voltage drop between the sense voltage and the voltage at the output pins from  $V_{O\text{nom}}$ . If the remote sense is not needed the sense pin should be left open.

## Operating Information

### Output Voltage Adjust ( $V_{adj}$ )

The output voltage can be set by means of an external resistor, connected to the  $V_{adj}$  pin. Nominal output voltage 0.75 V is set by leaving the  $V_{adj}$  pin open. Adjustment can only be made to increase the output voltage setting.

To increase:

Connect a resistor between ( $V_{adj}$ ) and (Gnd). The output voltage increases with decreasing resistor value as shown in the table below. Note that the maximum output voltage 3.63 V may not be exceeded.

$$R_{ext \text{ up}} (\text{kohm}) = (21.007 / (V_O - 0.75225)) - 5.1$$

Output Voltage (V)	Resistor (ohm)
0.75	Open
1.0	80 k
1.2	42 k
1.5	23 k
1.8	15 k
2.5	7 k
3.3	3.1 k

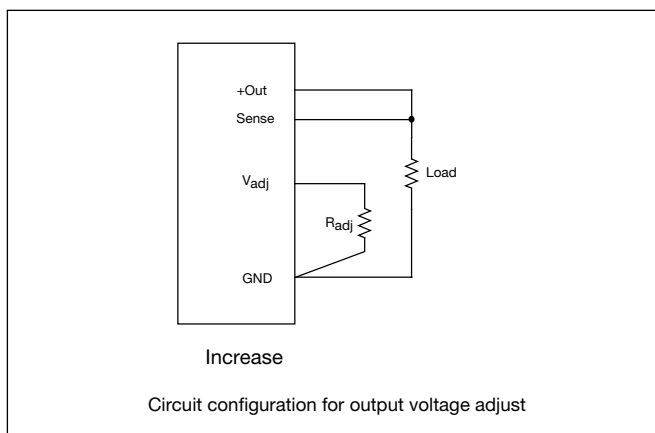

### Current Limit Protection

The PMC 4000 Series DC/DC regulators include current limiting circuitry that allows them to withstand continuous overloads or short circuit conditions on the output. The current limit is of hiccup mode type.

The regulator will resume normal operation after removal of the overload. The load distribution system should be designed to carry the maximum output short circuit current specified.

### Over Temperature Protection (OTP)

The PMC 4000 Series DC/DC regulators are protected from thermal overload by an internal over temperature shutdown circuit. When the reference temperature ( $T_{ref}$ ), see page 20, exceeds 160 °C the regulator will shut down immediately.

The regulator will return to normal operation when the over temperature degrades.

### Input And Output Impedance

The impedance of both the power source and the load will interact with the impedance of the DC/DC regulator. It is most important to have a low characteristic impedance, both at the input and output, as the regulators have a low energy storage capability. Use capacitors across the input if the source inductance is greater than 4.7  $\mu$ H. Suitable input capacitors are 22  $\mu$ F - 220  $\mu$ F low ESR ceramics.

Max output capacitance is 5000  $\mu$ F. The use of low ESR capacitors is important and should be <15 m $\Omega$ .

### Minimum Required External Capacitors

External input capacitors are required to increase the lifetime of the internal capacitors and to further reduce the input ripple. A minimum of 44  $\mu$ F external input capacitance with low ESR should be added.

A minimum of 150  $\mu$ F external output capacitance, low ESR, should be added for the converter to operate properly at full load.

### Maximum Capacitive Load

When powering loads with significant dynamic current requirements, the voltage regulation at the load can be improved by addition of decoupling capacitance at the load. The most effective technique is to locate low ESR ceramic capacitors as close to the load as possible, using several capacitors to lower the total ESR. These ceramic capacitors will handle short duration high-frequency components of dynamic load changes. In addition, higher values of capacitors should be used to handle the mid-frequency components. It is equally important to use good design practise when configuring the DC distribution system.

Low resistance and low inductance PCB layouts and cabling should be used. Remember that when using remote sensing, all resistance, inductance and capacitance of the distribution system is within the feedback loop of the regulator. This can affect on the regulators compensation and the resulting stability and dynamic response performance. The PMC 4000 series regulator can accept up to 5 mF of capacitive load on the output at full load. This gives <500  $\mu$ F/A of  $I_O$ .

## **Operating Information**

### **Parallel Operation**

The PMC 4000 Series DC/DC regulators can be connected in parallel with a common input. Paralleling is accomplished by connecting the output voltage pins directly and using a load sharing device on the input. Layout considerations should be made to avoid load imbalance. For more details on paralleling, please consult your local applications support.

### **Input Undervoltage Lockout**

The PMC 4000 Series DC/DC regulators are equipped with a lockout function for low input voltage. When the input voltage is below the undervoltage lockout limit of the regulator it will shut off. When the input voltage increases above the lockout level the regulator will turn on.

## Thermal Considerations

### General

The PMC 4000 Series DC/DC regulators are designed to operate in a variety of thermal environments, however sufficient cooling should be provided to help ensure reliable operation. Heat is removed by conduction, convection and radiation to the surrounding environment. Increased airflow enhances the heat transfer via convection.

Proper cooling can be verified by measuring the temperature at the reference point ( $T_{ref}$ ).

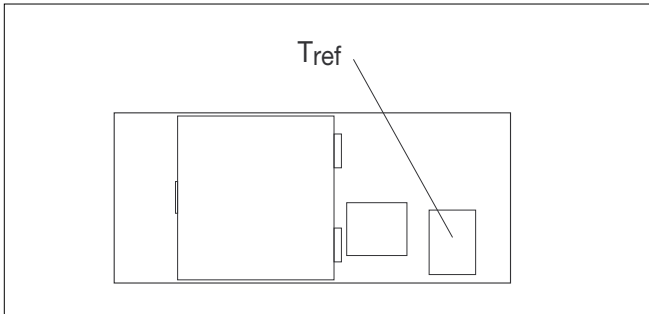

The PMC 4000 thermal testing is performed with the product mounted on an FR4 board 254 × 254 mm with 8 layers of 35 μm copper.

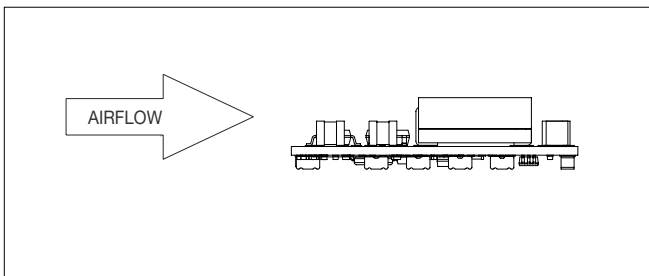

### Calculation of ambient temperature

By using the thermal resistance the maximum allowed ambient temperature can be calculated.

A. The powerloss is calculated by using the formula  
 $((1/\eta) - 1) \times \text{output power} = \text{power losses}$ .  
 $\eta$  = efficiency of regulator. Example: 95% = 0.95

B. Find the value of the thermal resistance  $R_{th T_{ref}-A}$  in the diagram by using the airflow speed at the module. Take the thermal resistance × powerloss to get the temperature increase.

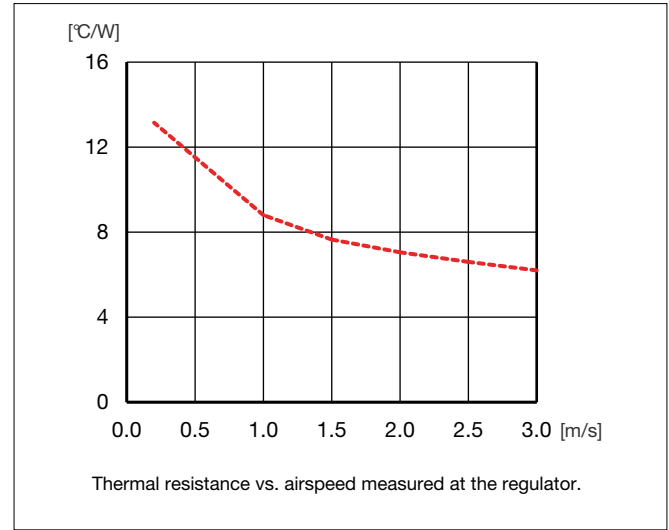

C. Max allowed calculated ambient temperature is:  
 Max  $T_{ref}$  of DC/DC regulator - temperature increase.

**Example:** 1.8 V output at 1m/s, full load, 3.3 V in:

A.  $((1/0.90) - 1) \times 18 \text{ W} = 2 \text{ W}$

B.  $2 \text{ W} \times 8.5 \text{ °C/W} = 17 \text{ °C}$

C.  $115 \text{ °C} - 17 \text{ °C} = \text{max ambient temperature is } 98 \text{ °C}$

The real temperature will be dependent on several factors, like PCB size and type, direction of airflow, air turbulence etc. It is recommended to verify the temperature by testing.

## Miscellaneous

### Soldering Information

Information not available at time of printing. Please contact your local sales contact for further information.

### Delivery Package Information

The PMC 4000 series regulators are delivered in antistatic tape & reel (EIA standards 481-2).

Tape & reel specification:

Material:	Conductive
Tape width:	44 mm [1.73 in.]
Tape pitch:	24 mm [0.95 in.]
Total pocket height:	9.1 mm [0.36 in.]
Reel diameter:	330 mm [13 in.]
Reel capacity:	200 pieces
Full reel weight:	typ. 2.0 kg

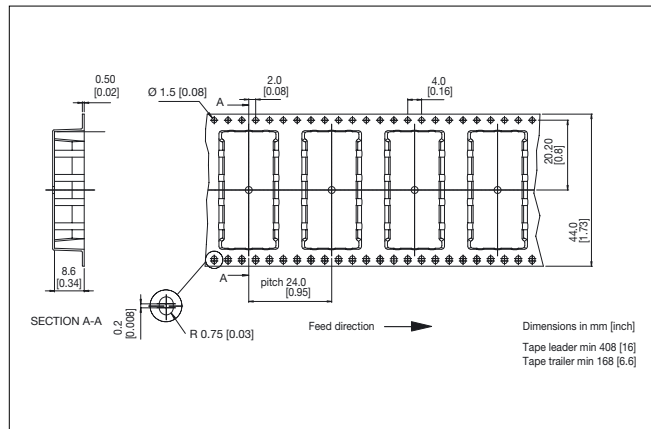

## Quality

### Reliability

The Mean Time Between Failure (MTBF) of the PMC 4000 series DC/DC regulator family is calculated to be greater than 17 million hours at full output power and a reference temperature of +40 °C using the Ericsson failure rate data system (TILDA/Preditool). The Ericsson failure rate data system is based on field failure rates and is continuously updated. The data corresponds to actual failure rates of components used in Information Technology and Telecom equipment in temperature controlled environments ( $T_A = -5...+65$  °C). The data is considered to have a confidence level of 90 %. For more information please refer to Design Note 002.

### Quality Statement

The PMC 4000 series DC/DC regulators are designed and manufactured in an industrial environment where quality systems and methods like ISO 9000, 6 $\sigma$  (sigma), and SPC are intensively in use to boost the continuous improvements strategy. Conservative design rules, design reviews and product qualifications, plus the high competence of an engaged work force, contribute to the high quality of our products.

### Limitation of Liability

Ericsson Power Modules does not make any warranties, expressed or implied including any warranty of merchantability or fitness for a particular purpose (including, but not limited to, use in life support applications, where malfunctions of product can cause injury to a person's health or life).

## Product Program

$V_I$	$V_O/I_O$ max	$P_O$ max	Ordering No.
	Output 1		
3.0-5.5 V*	0.8-3.6 V/10 A	36 W	PMC 4318T WS

\* Input voltage limited to 4.5-5.5V for output voltages of 3.3V and higher.

## Ordering Information

Delivery option	M.o.q.	Suffix	Example
Tape & Reel	200 pcs	/C	PMC 4xxxT WS /C

Information given in this data sheet is believed to be accurate and reliable. No responsibility is assumed for the consequences of its use nor for any infringement of patents or other rights of third parties which may result from its use. No license is granted by implication or otherwise under any patent or patent rights of Ericsson Power Modules. These products are sold only according to Ericsson Power Modules' general conditions of sale, unless otherwise confirmed in writing. Specifications subject to change without notice.

**Ericsson Power Modules**  
SE-141 75 Kungens Kurva, Sweden  
Telephone: +46 8 568 69620

For local sales contacts, please refer to our website  
[www.ericsson.com/powermodules](http://www.ericsson.com/powermodules)  
or call: Int +46 8 568 69620, Fax: +46 8 568 69599

**Americas**  
Ericsson Inc., Power Modules  
+1-972-583-5254, +1-972-583-6910

**Asia/Pacific**  
Ericsson Ltd.  
+852-2590-2453

The latest and most complete information can be found on our website

Advanced Product Information

EN/LZT 146 056 R1C  
© Ericsson Power Modules AB, February 2004